

CE IE3

MADE IN ITALY



**INDUSTRIAL range**



## K-MAX

Direct drive oil-injected screw compressors



Fixed and variable speed  
5.5-90 kW

# Company Profile

Fini boasts more than 60 years of experience and is one of the most important global organisations in the professional and industrial compressed air sector. Synonymous with quality and professionalism, the Fini brand not only provides one of the most comprehensive ranges in the field of rotary air compressors, but above all Fini is now established as a global reference point in terms of quality and technology recognised throughout the industrial compressed air sector.



All Fini industrial compressors are **MADE IN ITALY**, designed for heavy duty use, and distinguished for their unique and advanced technologies that provides energy saving solutions that work!

► Our compressors offer the ideal solution to the needs of larger-scale industry as well as smaller and mid-sized companies, where compressed air is a most important source of energy.

Fini Screw Compressors are designed for continuous duty in the most arduous operating conditions, with a special attention to reducing energy consumption, lowering operating and maintenance costs along with offering simple installation and ease of use.

► The entire production process, from project design and research through to the packaging of the final product is carried out at our facilities in Italy.

Our highly skilled work force are dedicated to supporting the manufacturing and assembling activities.

The continuous control and monitoring of each manufacturing process grants the utmost precision at every step, in order to achieve the highest quality and supreme product reliability.

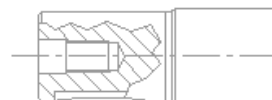

# Innovation, Quality and Know-how

Our engineering philosophy is based on the selection and highly controlled assembly of the most reliable and efficient technical solutions. The constant pursuit of excellence in quality, along with an innovative spirit and particular attention to the customers demands, are the values that have always characterised Fini and its products.



► Ongoing investments in technical and product innovation have led Fini to boost its industrial product range with the **K-MAX: rotary screw compressors with direct or gears transmission system, with power values from 5.5 up to 90 kW.**

► Testing conducted on automated lines, state of the art automated systems and IT equipment intended for design and control are the main investments that the company has made in order to manufacture products that fulfil the quality standards of the market. Since 1996, the Company has certified its quality system in accordance with UNI EN ISO 9001:2015 standards.

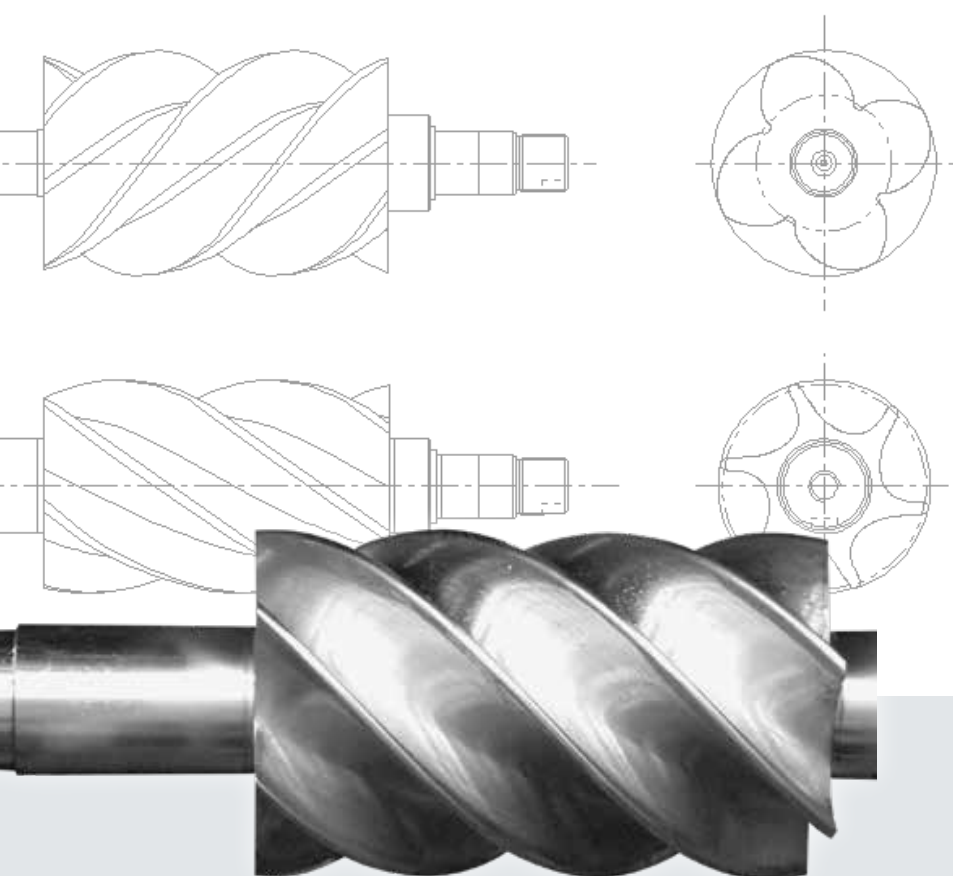

# Our TARGET: maximum efficiency, lower energy consumption and low noise impact.

The K-MAX screw compressors from 5.5 to 90 kW have been designed to minimize energy costs without sacrificing performance. The original design has been developed to obtain the best cooling performance with the least acoustic impact. Available in fixed or variable speed version, with pressures of 7.5, 8, 10 or 13 bar.



## The K-MAX range transmission system aims to maximize efficiency and reliability.

The direct or gear drive transmission minimises maintenance and increases the reliability and longevity of the machine. The combination of proven technologies, along with components designed and manufactured by Fini, guarantees high efficiency and constant maintenance of performance. In up to 15 kW compressors, power transmission without loss can bring a 4% advantage compared to a normal belt driven compressor, thanks to its special motor with a tubular crankcase and no frontal bearing.



▶ Transmission system with **tubular crankcase**, provided on the models: 5.5 - 7.5 - 11 - 15.



▶ Transmission system with **gears**, provided on the models: 22 - 31 - 45 - 55 - 75 - 75E.

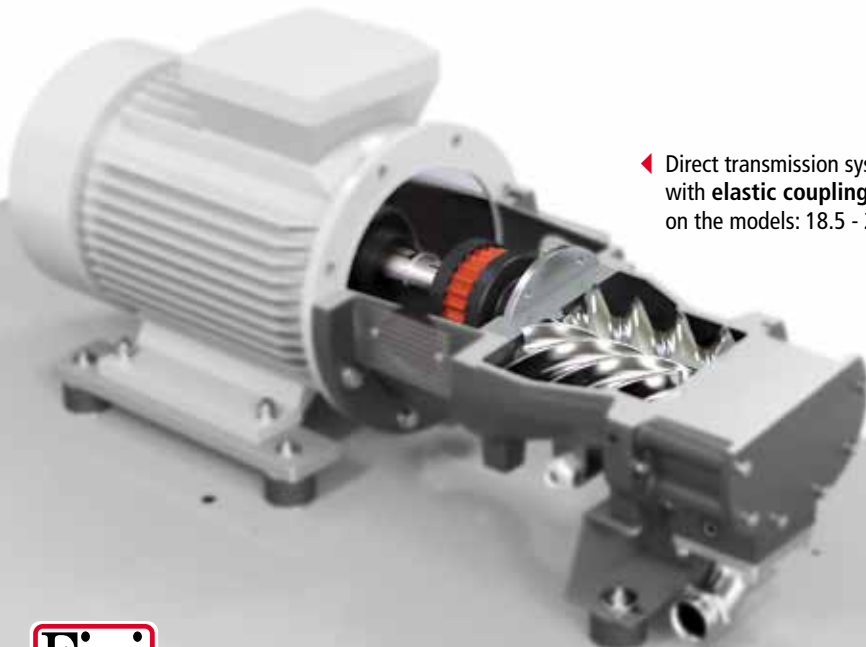

◀ Direct transmission system with **elastic coupling**, provided on the models: 18.5 - 22 - 31 - 38 - 45 - 55.

▼ Transmission system with **gears**, provided on the models: 76 - 90.



# Why you should choose a Fini SCREW compressor?

- ▶ To have a 100% Italian product.
- ▶ To cut operating costs.
- ▶ To have the most modern, compact, efficient, reliable and quiet screw compressor.
- ▶ To provide a continuous source of compressed air.
- ▶ To monitor the remote compressor activity.
- ▶ To save energy and reduce CO<sub>2</sub> emissions.



## High energy saving

The IE3 high efficiency motors, combined with high performance air-ends, allow you to cut energy costs. Moreover, IE3 motors reduce CO<sub>2</sub> emissions: an important contribution to protecting the environment.

## Plug&Play

Our K-MAX compressors are thoroughly tested in our factories to ensure they are ready for immediate use following delivery, thereby saving time and cutting installation costs.



## Low noise levels

K-MAX compressors are very quiet: efficient soundproofing materials, lower speed and radial cooling fans make them suitable for installation even near workstations.



## Simplified maintenance

The use of selected components, supplied by leading manufacturers worldwide, guarantees a long operational life and long maintenance intervals. The constructive layout is designed to facilitate access to internal components and therefore all maintenance operations.



## Remote monitoring

Thanks to the SMS Device, complete remote control of the compressor is possible from any device (Smartphone, Tablet, PC, etc.). The SMS Device, in addition, automatically sends e-mails in case of alarms and according to pre-established thresholds.

The air-ends, inverters and controllers are covered by a **2-YEAR WARRANTY** that can be extended up to 5 years by joining the Trust program (info on pages 22-23).



AIR-END



CONTROLLER



INVERTER



40 dB(A)



62 dB(A)



only 58 dB(A)

COMPETITORS



65-77 dB(A)



100 dB(A)



120 dB(A)

# ETIV Advanced electronic controller

The advanced ETIV controller installed on the K-MAX range has been specially designed to ensure optimal monitoring and regulation of the operation of the compressor, allowing flexibility and complete programming, to ensure maximum efficiency and safety.



Controller with multi-function backlight LCD graphic display, the menu is drop down type. The main screen display indicates:

- ▶ operating pressure values;
- ▶ oil temperature values;
- ▶ compressor status (stand-by, idle, loaded);
- ▶ fan status (on/off);
- ▶ date and time;
- ▶ remaining hours for maintenance;
- ▶ drive speed percentage (for machines with an inverter)
- ▶ duty cycle compressor (total and load hours)

## ▶ Weekly programming

With the ETIV controller, it is possible to set up to 9 independent operating programs.

For each program it is possible to set the switching on and off times, the days of the week in which it must work and the relative pressure range.

In case of a system with several compressors, both at fixed and variable speed, it is possible to set various programs to create a "virtual network" (without the need to physically connect them together).

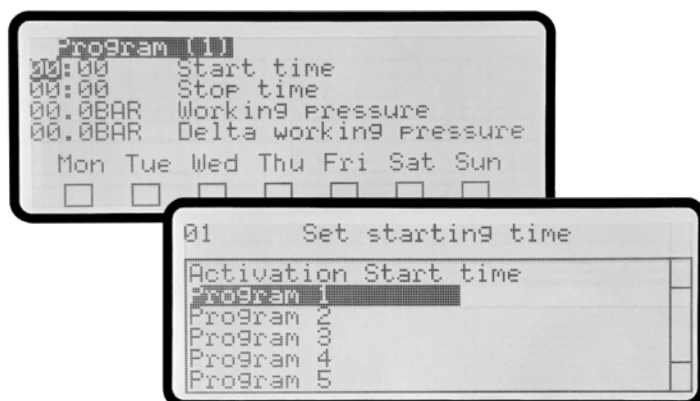

# EasyX4 Optimised control in the compressor room

Many compressed air stations include several compressors: **EasyX4** is the easiest solution to manage complex compressor systems, with fixed speed, programmable on a weekly basis, capable of configuring up to 4 units, based on the amount of air actually required.

## Three programming levels:

- ▶ **MANUAL:** compressors set on a given operating pressure range;
- ▶ **AUTOMATIC:** with pressure range exchange after a programmable time period;
- ▶ **GROUP PROGRAMMING:** the compressors can be switched within groups.

#405531604 EASY X4 CONTROL UNIT



# SMS Device Service Management System

SMS is the innovative device for remote control and predictive maintenance of screw compressors fitted with an ETIV controller. If the device is configured on internet networks via Wi-Fi or Ethernet, e-mails can be automatically sent in case of faults and/or automatic periodic e-mails (every hour, every day, every week) so as to monitor correct compressor operation and the remaining hours for the main scheduled maintenance.

## Preventive and targeted maintenance:

- ▶ automatic sending of e-mails in case of alarms,
- ▶ possibility of sending e-mails which notify the compressor status and settings at pre-set intervals (hourly, daily or weekly).

## Remote control of the compressor:

- ▶ no additional software is required,
- ▶ on/off control,
- ▶ access to the various menu levels (user, service),
- ▶ compressor online status check.



9062744

ANTENNA+SMS DEVICE KIT

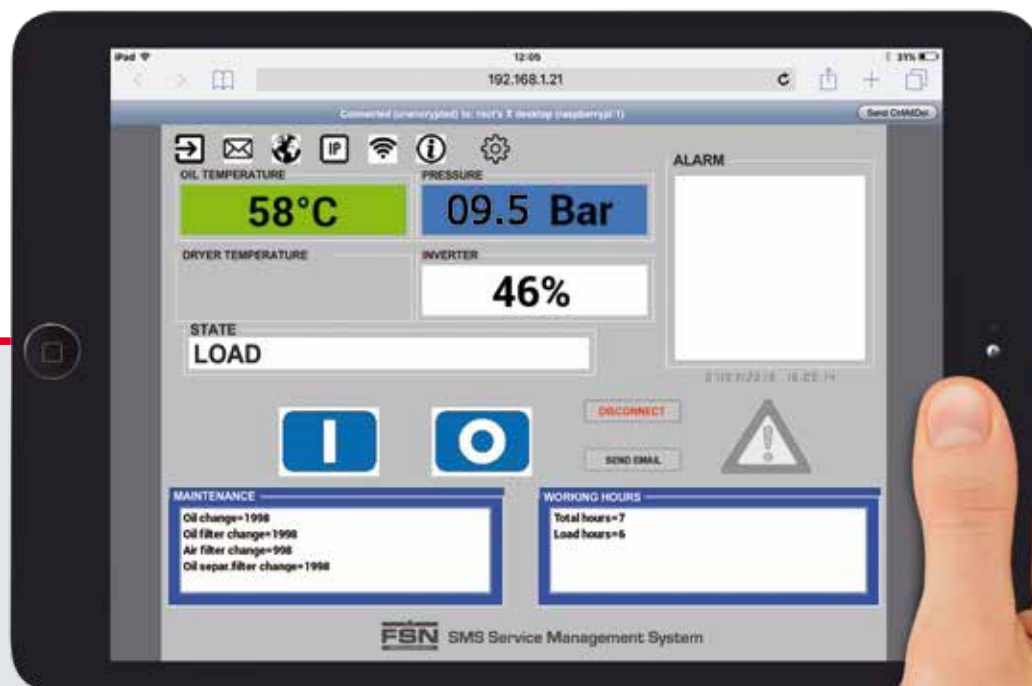

# Variable speed to reduce energy consumption

Nowadays, reducing energy consumption and protecting our precious resources represent one of the greatest environmental challenges worldwide. The **K-MAX** series is also available in the Variable Speed version (VS models from 7.5 to 90 kW), offering high performance combined with energy-saving solutions.

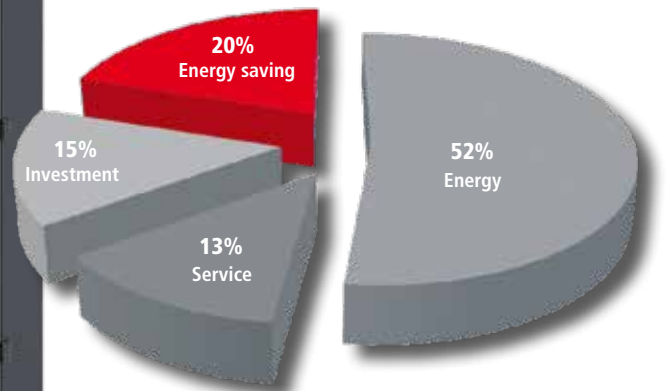

#### MANAGEMENT COSTS

The graph shows the significant energy saving using variable speed compressors in a typical installation.

The inverter application of a leading world manufacturer, able to dynamically adjust the voltage/frequency/current values of the motor, allows the elimination of unnecessary power losses by constantly adjusting the generation of compressed air to match the real air demand, offering many proven advantages for the user in terms of reducing energy consumption:

- ▶ Continuous regulation of the motor speed and compressed air generation to precisely match the air demand.
- ▶ The air output is constantly adjusted between 40% and 100% of the compressor full capacity.
- ▶ Constant and accurate air pressure.
- ▶ Energy consumption is proportional to the delivered compressed air.





# EATool - EASoftware Detection and analysis of energy consumption

The energy efficiency of a production plant using compressed air allows for countless advantages for the company's entire production process, in terms of consumption and costs.

Based on decades of experience in the industrial sector, Fini provides a professional auditing service to companies, through skilled technicians and advanced measurement and analysis equipment (EATool and EASoftware). Such equipment allows us to offer one or more rotary screw compressors, in alternative to the existing ones, to achieve considerable annual economic and energy savings.



## EATool

- ▶ Designed to measure pneumatic systems where up to 4 compressors work.
- ▶ Measurements are downloaded to a USB drive (included).
- ▶ Supplied: up to 4 x 400 A ampere clamps (optional up to 1000A) and a pressure probe.
- ▶ Possible equipment sale or rental.

## EASoftware

- ▶ Acquires the actual consumption of a compressed air system.
- ▶ Processes a complete Energy Audit of the system.
- ▶ Suggests one or more compressors as an alternative to the existing ones, to achieve the highest energy savings.

9062747

EATOOL EA400

# K-MAX 5.5-37 kW Designed for a long service life.



## ■ Innovative cooling system

The equipment has one of the most innovative cooling systems in the sector: a thermostatic-control centrifugal fan that ensures the temperature inside the compressor remains within a specific tolerance and at a constant level, avoiding temperature peaks that may prevent the machine from operating correctly. The action of the fan, combined with the efficiency of the oversized oil radiator, ensures that the compressor also operates under critical weather conditions.

The "silent" fans, the specially designed labyrinth ventilation and the use of top quality soundproofing materials ensure one of the lowest acoustic levels of the range.



K-MAX 11-15  
front and rear view



## ■ Easy to transport

With the easily removable panel located at the base of the compressor, the machine can be effortlessly transported with a pallet truck or a forklift truck, whilst at the same time ensuring considerably lower noise levels. The versions on a tank are also equipped with lifting bars on the base, both at the front and the back.



## ■ Simplified maintenance

The oil filter and "spin-on" type of oil separator filter are easy to replace, offer a long service life and low maintenance costs.

# Noise and temperature under control.



## ■ High performance

The screw air-ends, exclusively designed by Fini, are entirely manufactured and tested in our Italian factory; the special design of the rotor profile ensures high performance.



## ■ Cleaning and protection

The pre-filter panel separates incoming dust and keeps the inside of the machine clean, thereby increasing the life cycle of the internal components.



**K-MAX 38**  
front and rear view



## ■ High-efficiency IE3 motors

In conjunction with Fini high performance screw units, the "Premium Efficiency" IE3 motors by a top global manufacturer ensure lower energy costs. Moreover, IE3 motors help reduce CO<sub>2</sub> emissions.



## ■ Intake valve

The intake valve is entirely designed and manufactured at our facilities. This most important device, adjusts the compressor's operation to guarantee minimum pressure during idle running and maximum savings upon start-up.

# K-MAX 45-90 kW Designed for a long service life.



■ **Thermostatic valve (only 75-76 and 90 versions)**  
Controls the coolant flow avoiding sudden temperature changes and reduces the risk of condensation being formed within the lubrication circuit.

■ **Cleaning and protection** ■  
The pre-filter panel separates incoming dust and keeps the inside of the machine clean, thereby increasing the life cycle of the internal components.



■ **Heat exchangers**

Generously dimensioned coolers combining high efficiency heat transfer and low pressure losses.

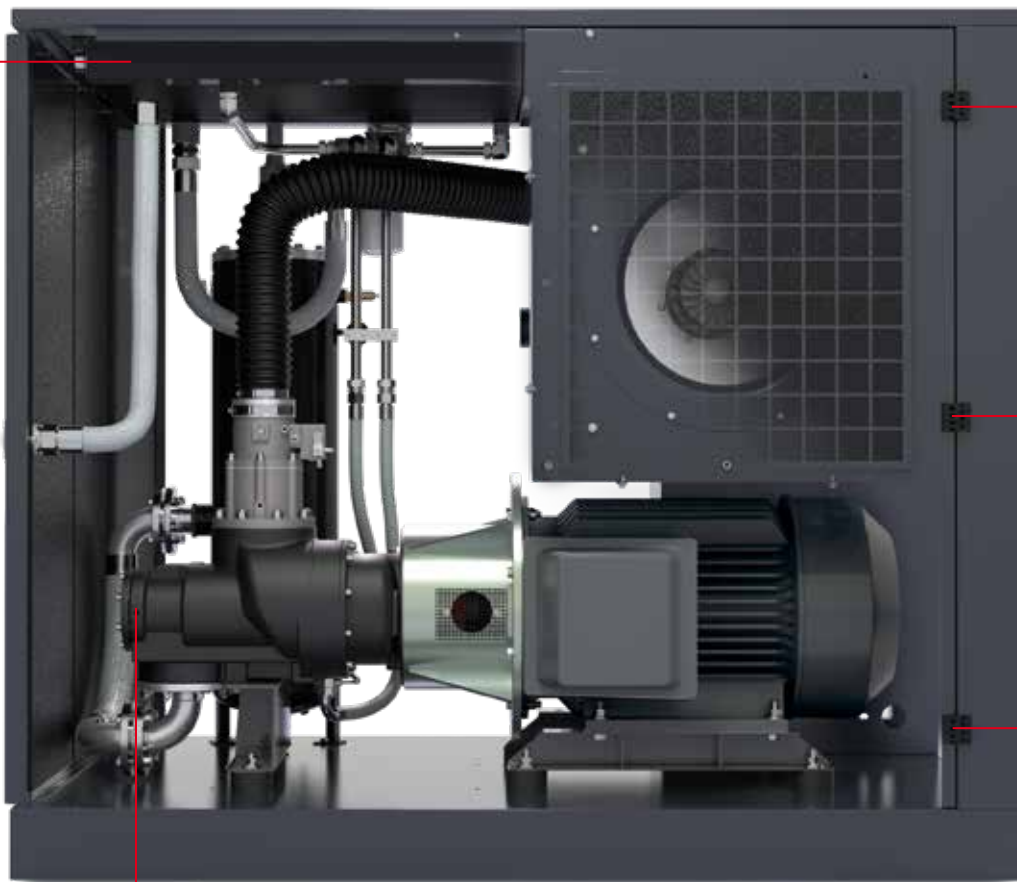

■ The machine can be fully opened on all 4 sides. The front and rear panels have hinges ensuring 180° opening.

◀ **K-MAX 90**  
rear view



■ **Simplified maintenance**  
The screw-motor unit is completely removable from the machine. The oil filter and air filter are ideally positioned for easy access, simplifying maintenance operations.

■ **High efficiency air-ends**  
The special design of the rotor profile ensures high performance.



■ **Energy saving**  
The intake regulator adjusts the compressor's operation to guarantee minimum pressure during idle running and maximum savings upon start-up.

# Noise and temperature under control.



## ■ Innovative cooling system

The thermostatic-controlled centrifugal fan ensures the temperature inside the compressor remains within a specific tolerance and at a constant level, avoiding temperature peaks that may prevent the machine from operating correctly.

The action of the fan, combined with the efficiency of the oversized oil radiator, ensures that the compressor also operates under critical weather conditions.

The use of "silent" fans and top quality soundproofing materials ensure one of the lowest acoustic levels of its range.



◀ K-MAX 90  
front view



## ■ Easy to transport

The palletized base allows a good portability of the machine with a pallet truck or a forklift truck.



## ■ High-efficiency IE3 motors

The "Premium Efficiency" IE3 motors by a top global manufacturer, combined with high-efficiency air-ends, ensure lower energy costs. Moreover, IE3 motors help to reduce CO<sub>2</sub> emissions.

# K-MAX 5.5 - 15 kW: modular design.

The Fini K-MAX series from 5.5 to 15 kW is available in a variety of configurations to suit the exact requirements of the customer: starting with the standard floor mounted version, the range can also be selected with a 270 or 500 litre air receiver, with or without refrigerated dryer, also available with inverter (variable speed control) drive. The whole machine forms an extremely compact and aesthetic design.

- ▶ Direct drive technology for maximum reliability.
- ▶ High performances provides excellent efficiency.
- ▶ Intelligent microprocessor control system.
- ▶ Very compact design.
- ▶ No drive belts for less maintenance.
- ▶ "ES" versions are equipped with refrigerating air dryer, supplied ready to operate with a minimum of installation.



## K-Max 5.5 - 7.5

5.5 - 7.5 kW

### Available versions:

- floor mounted compressor
- compressor + air dryer (7.5 kW version only)
- compressor + air receiver
- compressor + air receiver + air dryer
  
- fixed speed
- variable speed (7.5 kW version only)

### Air-end:

FSC 26

### Controller:

ETIV

## K-Max 11 - 15

11 - 15 kW

### Available versions:

- floor mounted compressor
- compressor + air dryer
- compressor + air receiver
- compressor + air receiver + air dryer
  
- fixed and variable speed

### Air-end:

FSC 50

### Controller:

ETIV

# K-MAX 18.5 - 37 kW: a quality choice.

## Dryer module

Some K-MAX (up to 37 kW) are also available in the "ES" version with a refrigerated dryer: the dryer guarantees the production of dry and good quality air, which is essential to preserving the systems and the quality of the final product, and allows excellent performance to be achieved also in adverse environmental conditions and high inlet temperatures.



## K-Max 18.5 - 22

18.5 - 22 kW

### Available versions:

- floor mounted compressor
- compressor + air dryer (22 kW version only)
- fixed and variable speed

### Air-end:

FS 100  
FS 130

### Controller:

ETIV

## K-Max 31 - 38

30 - 37 kW

### Available versions:

- floor mounted compressor
- compressor + air dryer (37 kW version only)
- fixed and variable speed

### Air-end:

FS 190  
FS 260

### Controller:

ETIV

# K-MAX 45 - 90 kW compact design meets high performance.



## K-Max 45 - 55 - 75E

45-55-75 kW

### Available versions:

- floor mounted compressor
- fixed and variable speed

### Air-end

FS 260

### Controller:

ETIV

## K-Max 75 - 76 - 90

75-90 kW

### Available versions:

- floor mounted compressor
- fixed and variable speed

### Air-end:

FS 260 ("75" versions)  
FS 300 ("76" and "90" versions)

### Controller:

ETIV





# 18.5 - 22 kW

Model	CODE	ℓ	Free air delivered (max. / min)		MAX		dB(A)	BSP	Weight		Dimensions		Weight		Dimensions	
			kW	HP	m³/min.	c.f.m.			bar	psi	kg	Lbs	L x W x H (cm)	kg	Lbs	L x W x H (cm)
<b>FIXED SPEED</b>																
<b>K-MAX 18.5-10</b>	<b>V60DQ92FNM060</b>	-	18.5	25	2.6	92	10	145	62	1-1/4"	526	1,160	133 x 85 x 137	607	1,338	153 x 104 x 166
<b>VARIABLE SPEED</b>																
<b>K-MAX 18.5-08 VS</b>	<b>V60DP97FNM060</b>	-	18.5	25	3.1 / 1.07	109 / 38	7.5	109	62	1-1/4"	541	1,193	133 x 85 x 137	622	1,371	153 x 104 x 166
<b>K-MAX 18.5-10 VS</b>	<b>V60DQ97FNM060</b>	-	18.5	25	2.6 / 0.93	92 / 33	10	145	62	1-1/4"	541	1,193	133 x 85 x 137	622	1,371	153 x 104 x 166

Model	CODE	ℓ	Free air delivered (max. / min)		MAX		dB(A)	BSP	Weight		Dimensions		Weight		Dimensions	
			kW	HP	m³/min.	c.f.m.			bar	psi	kg	Lbs	L x W x H (cm)	kg	Lbs	L x W x H (cm)
<b>FIXED SPEED</b>																
<b>K-MAX 22-08</b>	<b>V60DR92FNM060</b>	-	22	30	3.6	127	7.5	109	58	1-1/4"	515	1,135	133 x 85 x 137	596	1,314	153 x 104 x 166
<b>K-MAX 22-08 ES</b>	<b>V60DR92FNM160</b>	-	22	30	3.6	127	7.5	109	58	1-1/4"	572	1,261	171 x 85 x 137	662	1,459	205.5 x 114 x 166
<b>VARIABLE SPEED</b>																
<b>K-MAX 22-08 VS</b>	<b>V60DR97FNM060</b>	-	22	30	3.6 / 1.17	127 / 41	7.5	109	62	1-1/4"	530	1,168	133 x 85 x 137	611	1,347	153 x 104 x 166
<b>K-MAX 22-10 VS</b>	<b>V60DS97FNM060</b>	-	22	30	3.01 / 1.17	106 / 41	10	145	60	1-1/4"	530	1,168	133 x 85 x 137	611	1,347	153 x 104 x 166
<b>K-MAX 22-13 VS</b>	<b>V60DT97FNM060</b>	-	22	30	2.56 / 0.97	90 / 34	13	189	60	1-1/4"	530	1,168	133 x 85 x 137	611	1,347	153 x 104 x 166
<b>K-MAX 22-08 ES VS</b>	<b>V60DR97FNM160</b>	-	22	30	3.6 / 1.17	127 / 41	7.5	109	62	1-1/4"	587	1,294	171 x 85 x 137	677	1,493	205.5 x 114 x 166
<b>K-MAX 22-10 ES VS</b>	<b>V60DS97FNM160</b>	-	22	30	3.01 / 1.17	106 / 41	10	145	60	1-1/4"	587	1,294	171 x 85 x 137	677	1,493	205.5 x 114 x 166
<b>K-MAX 22-13 ES VS</b>	<b>V60DT97FNM160</b>	-	22	30	2.56 / 0.97	90 / 34	13	189	60	1-1/4"	587	1,294	171 x 85 x 137	677	1,493	205.5 x 114 x 166

# 30 - 37 kW

Model	CODE	ℓ	Free air delivered (max. / min)		MAX		dB(A)	BSP	Weight		Dimensions		Weight		Dimensions	
			kW	HP	m³/min.	c.f.m.			bar	psi	kg	Lbs	L x W x H (cm)	kg	Lbs	L x W x H (cm)
<b>FIXED SPEED</b>																
<b>K-MAX 31-08 *</b>	<b>V60DY92FNM060</b>	-	30	40	4.85	171	7.5	109	68	1-1/2"	822	1,812	159 x 100 x 156	909	2,004	180 x 120 x 190
<b>K-MAX 31-10 *</b>	<b>V60DX92FNM060</b>	-	30	40	4.3	152	10	145	68	1-1/2"	822	1,812	159 x 100 x 156	909	2,004	180 x 120 x 190
<b>VARIABLE SPEED</b>																
<b>K-MAX 31-08 VS</b>	<b>V60DY97FNM060</b>	-	30	40	4.85 / 1.99	171 / 70	7.5	109	66	1-1/2"	845	1,863	159 x 100 x 156	932	2,055	180 x 120 x 190
<b>K-MAX 31-10 VS</b>	<b>V60DX97FNM060</b>	-	30	40	4.3 / 1.61	152 / 57	10	145	66	1-1/2"	845	1,863	159 x 100 x 156	932	2,055	180 x 120 x 190









Model	CODE	ℓ	Free air delivered (max. / min)		MAX		dB(A)	BSP	Weight		Dimensions		Weight		Dimensions	
			kW	HP	m³/min.	c.f.m.			bar	psi	kg	Lbs	L x W x H (cm)	kg	Lbs	L x W x H (cm)
<b>FIXED SPEED</b>																
<b>K-MAX 38-08</b>	<b>V60DU92FNM060</b>	-	37	50	6.6	233	7.5	109	70	1-1/2"	902	1,989	159 x 100 x 156	989	2,180	180 x 120 x 190
<b>K-MAX 38-08 ES</b>	<b>V60DU92FNM160</b>	-	37	50	6.6	233	7.5	109	70	1-1/2"	982	2,165	196 x 100 x 156	1,079	2,379	213 x 120 x 190
<b>VARIABLE SPEED</b>																
<b>K-MAX 38-08 VS</b>	<b>V60DU97FNM060</b>	-	37	50	6.6 / 2.68	233 / 95	7.5	109	69	1-1/2"	925	2,039	159 x 100 x 156	1,012	2,231	180 x 120 x 190
<b>K-MAX 38-10 VS</b>	<b>V60DV97FNM060</b>	-	37	50	5.4 / 1.72	191 / 61	10	145	66	1-1/2"	985	2,172	159 x 100 x 156	1,072	2,363	180 x 120 x 190
<b>K-MAX 38-13 VS</b>	<b>V60DW97FNM060</b>	-	37	50	4.52 / 1.71	160 / 60	13	189	66	1-1/2"	985	2,172	159 x 100 x 156	1,072	2,363	180 x 120 x 190
<b>K-MAX 38-08 ES VS</b>	<b>V60DU97FNM160</b>	-	37	50	6.6 / 2.68	233 / 95	7.5	109	69	1-1/2"	1,005	2,216	196 x 100 x 156	1,102	2,429	213 x 120 x 190
<b>K-MAX 38-10 ES VS</b>	<b>V60DV97FNM160</b>	-	37	50	5.4 / 1.72	191 / 61	10	145	66	1-1/2"	1,065	2,348	196 x 100 x 156	1,162	2,562	213 x 120 x 190
<b>K-MAX 38-13 ES VS</b>	<b>V60DW97FNM160</b>	-	37	50	4.52 / 1.71	160 / 60	13	189	66	1-1/2"	1,065	2,348	196 x 100 x 156	1,162	2,562	213 x 120 x 190

\* Drive with gears.









ES = WITH AIR DRYER

VS = VARIABLE SPEED









# 45 - 55 - 75 kW

Model	CODE	$l$			Free air delivered (max. / min)													
			kW	HP	m³/min.	c.f.m.	bar	psi			dB(A)	BSP	kg	Lbs	L x W x H (cm)	kg	Lbs	L x W x H (cm)
<b>FIXED SPEED</b>																		
<b>K-MAX 45-08 *</b>	V60FU92FNM060	-	45	60	8.2	290	7.5	109	72	2"	1,251	2,758	170 x 125 x 170	1,362	3,003	192 x 142 x 188		
<b>K-MAX 45-10</b>	V60FV92FNM060	-	45	60	6.7	237	10	145	72	2"	1,194	2,632	170 x 125 x 170	1,305	2,877	192 x 142 x 188		
<b>VARIABLE SPEED</b>																		
<b>K-MAX 45-08 VS</b>	V60FU97FNM060	-	45	60	8.2 / 3	290 / 106	7.5	109	72	2"	1,222	2,694	170 x 125 x 170	1,326	2,923	192 x 142 x 188		
<b>K-MAX 45-10 VS</b>	V60FV97FNM060	-	45	60	6.7 / 2.4	237 / 85	10	145	72	2"	1,222	2,694	170 x 125 x 170	1,326	2,923	192 x 142 x 188		









  

Model	CODE	$l$			Free air delivered (max. / min)													
			kW	HP	m³/min.	c.f.m.	bar	psi			dB(A)	BSP	kg	Lbs	L x W x H (cm)	kg	Lbs	L x W x H (cm)
<b>FIXED SPEED</b>																		
<b>K-MAX 55-08 *</b>	V60FW92FNM060	-	55	75	10.1	357	7.5	109	72	2"	1,251	2,758	170 x 125 x 170	1,355	2,987	192 x 142 x 188		
<b>K-MAX 55-10 *</b>	V60FX92FNM060	-	55	75	8.3	293	10	145	72	2"	1,251	2,758	170 x 125 x 170	1,355	2,987	192 x 142 x 188		
<b>K-MAX 55-13</b>	V60FY92FNM060	-	55	75	6.5	230	13	189	72	2"	1,251	2,758	170 x 125 x 170	1,355	2,987	192 x 142 x 188		
<b>K-MAX 75E-08 *</b>	V60QU92FNM060	-	75	100	12.6	445	7.5	109	72	2"	1,440	3,175	170 x 125 x 170	1,560	3,439	192 x 142 x 188		
<b>K-MAX 75E-10 *</b>	V60QV92FNM060	-	75	100	10.5	371	10	145	72	2"	1,440	3,175	170 x 125 x 170	1,560	3,439	192 x 142 x 188		
<b>K-MAX 75E-13 *</b>	V60QW92FNM060	-	75	100	8.7	307	13	189	72	2"	1,440	3,175	170 x 125 x 170	1,560	3,439	192 x 142 x 188		
<b>VARIABLE SPEED</b>																		
<b>K-MAX 55-08 VS *</b>	V60FW97FNM060	-	55	75	10.1 / 3.6	357 / 127	7.5	109	72	2"	1,279	2,820	170 x 125 x 170	1,383	3,049	192 x 142 x 188		
<b>K-MAX 55-10 VS</b>	V60FX97FNM060	-	55	75	8.3 / 3	293 / 106	10	145	72	2"	1,279	2,820	170 x 125 x 170	1,383	3,049	192 x 142 x 188		
<b>K-MAX 55-13 VS</b>	V60FY97FNM060	-	55	75	6.5 / 2.3	230 / 81	13	189	72	2"	1,279	2,820	170 x 125 x 170	1,383	3,049	192 x 142 x 188		
<b>K-MAX 75E-08 VS *</b>	V60QU97FNM060	-	75	100	12.6 / 4.5	445 / 159	7.5	109	69	2"	1,486	3,276	170 x 125 x 170	1,600	3,527	192 x 142 x 188		
<b>K-MAX 75E-10 VS *</b>	V60QV97FNM060	-	75	100	10.5 / 3.8	371 / 134	10	145	69	2"	1,486	3,276	170 x 125 x 170	1,600	3,527	192 x 142 x 188		
<b>K-MAX 75E-13 VS *</b>	V60QW97FNM060	-	75	100	8.7 / 3.48	307 / 123	13	189	69	2"	1,486	3,276	170 x 125 x 170	1,600	3,527	192 x 142 x 188		

# 75 - 90 kW

Model	CODE	$l$			Free air delivered (max. / min)													
			kW	HP	m³/min.	c.f.m.	bar	psi			dB(A)	BSP	kg	Lbs	L x W x H (cm)	kg	Lbs	L x W x H (cm)
<b>FIXED SPEED</b>																		
<b>K-MAX 75-08 *</b>	V60FA92FNM160	-	75	100	12.6	445	7.5	109	69	2"	2,760	6,085	230 x 146 x 196	2,940	6,482	256 x 166 x 223		
<b>K-MAX 75-10 *</b>	V60FB92FNM160	-	75	100	10.5	371	10	145	69	2"	2,760	6,085	230 x 146 x 196	2,940	6,482	256 x 166 x 223		
<b>K-MAX 75-13 *</b>	V60FC92FNM160	-	75	100	8.7	307	13	189	69	2"	2,760	6,085	230 x 146 x 196	2,940	6,482	256 x 166 x 223		
<b>K-MAX 76-08</b>	V60FA92FNM060	-	75	100	13.5	477	7.5	109	67	2"	2,890	6,371	230 x 146 x 196	3,070	6,768	256 x 166 x 223		
<b>K-MAX 76-10</b>	V60FB92FNM060	-	75	100	11.7	413	10	145	67	2"	2,890	6,371	230 x 146 x 196	3,070	6,768	256 x 166 x 223		
<b>K-MAX 76-13</b>	V60FC92FNM060	-	75	100	9.7	343	13	189	67	2"	2,890	6,371	230 x 146 x 196	3,070	6,768	256 x 166 x 223		
<b>VARIABLE SPEED</b>																		
<b>K-MAX 75-08 VS *</b>	V60FA97FNM160	-	75	100	12.6 / 4.5	445 / 159	7.5	109	69	2"	2,820	6,217	230 x 146 x 196	3,000	6,614	256 x 166 x 223		
<b>K-MAX 75-10 VS *</b>	V60FB97FNM160	-	75	100	10.5 / 3.8	371 / 134	10	145	69	2"	2,820	6,217	230 x 146 x 196	3,000	6,614	256 x 166 x 223		
<b>K-MAX 75-13 VS *</b>	V60FC97FNM160	-	75	100	8.7 / 3.48	307 / 123	13	189	69	2"	2,820	6,217	230 x 146 x 196	3,000	6,614	256 x 166 x 223		
<b>K-MAX 76-08 VS</b>	V60FA97FNM060	-	75	100	13.5 / 4.9	477 / 173	7.5	109	67	2"	2,935	6,471	230 x 146 x 196	3,115	6,867	256 x 166 x 223		
<b>K-MAX 76-10 VS</b>	V60FB97FNM060	-	75	100	11.7 / 4.2	413 / 148	10	145	66	2"	2,935	6,471	230 x 146 x 196	3,115	6,867	256 x 166 x 223		
<b>K-MAX 76-13 VS</b>	V60FC97FNM060	-	75	100	9.7 / 3.5	343 / 124	13	189	67	2"	2,935	6,471	230 x 146 x 196	3,115	6,867	256 x 166 x 223		

Model	CODE	$l$			Free air delivered (max. / min)													
			kW	HP	m³/min.	c.f.m.	bar	psi			dB(A)	BSP	kg	Lbs	L x W x H (cm)	kg	Lbs	L x W x H (cm)
<b>FIXED SPEED</b>																		
<b>K-MAX 90-08</b>	V60FH92FNM060	-	90	125	15.9	562	7.5	109	67	2"	2,927	6,453	230 x 146 x 196	3,107	6,850	256 x 166 x 223		
<b>K-MAX 90-10</b>	V60FJ92FNM060	-	90	125	13.4	473	10	145	67	2"	2,927	6,453	230 x 146 x 196	3,107	6,850	256 x 166 x 223		
<b>K-MAX 90-13</b>	V60FK92FNM060	-	90	125	10.4	367	13	189	67	2"	2,927	6,453	230 x 146 x 196	3,107	6,850	256 x 166 x 223		
<b>VARIABLE SPEED</b>																		
<b>K-MAX 90-08 VS</b>	V60FH97FNM060	-	90	125	15.9 / 5.7	562 / 201	7.5	109	68	2"	2,981	6,572	230 x 146 x 196	3,161	6,969	256 x 166 x 223		
<b>K-MAX 90-10 VS</b>	V60FJ97FNM060	-	90	125	13.4 / 4.8	473 / 170	10	145	70	2"	2,981	6,572	230 x 146 x 196	3,161	6,969	256 x 166 x 223		
<b>K-MAX 90-13 VS</b>	V60FK97FNM060	-	90	125	10.4 / 3.7	367 / 131	13	189	66	2"	2,981	6,572	230 x 146 x 196	3,161	6,969	256 x 166 x 223		

Free air delivery as per ISO 1217 Annex C, at 7 - 9.5 - 12.5 bar at the compressor outlet. ± 3 dB (A) as PNEUROP/CAGI PN-NTC 2.3.

\* Drive with gears.

VS = VARIABLE SPEED

# Long Life Kit for screw compressors scheduled maintenance.

- ▶ **FSN original spare parts** have been rigorously selected, checked and tested by specialised technicians to ensure the utmost efficiency and endurance of the compressor. The parts are stocked in our "LOGIMAT" centralised and automated warehouse in Zola Predosa (BO) - Italy, where 12,000 part codes on 10,000 sqm are managed every day.
- ▶ Specialised staff are continuously in contact with our distribution centres worldwide, to deliver spare parts to our customers in the shortest possible time.
- ▶ To make it easier to replace components throughout the various maintenance intervals specified in the use and maintenance manuals, Fini developed its **LONG LIFE KITS**, specifically created for all screw compressor models. Using Long Life Kit ensures the maximum performances of the compressor. You can download the LLK catalogues from the website [www.finicompressors.com](http://www.finicompressors.com) and see the exploded drawings and spare parts, constantly updated for each compressor model.



**LONG LIFE KIT**

**MANUTENZIONE PROGRAMMATA - SCHEDULED MAINTENANCE**

**FSN**

**K-MAX 18.5 - 30 kW**

Intervallo (h)	Kit A	Kit B
ogni 2.000 h	Kit A	Kit B
ogni 4.000 h	Kit A	Kit B
ogni 8.000 h	Kit A	Kit B

**K-MAX 18.5 - 30 kW**

Componente	Quantità	Numero di parte
...	...	...



# RotarEcofluid mineral based lubricants

- ▶ Formulated with high quality selected mineral base oils enhanced with advanced anti-oxidants, anti-wear (zinc free), rust preventers and antifoams, the **FSN RotarECOFLUID** oil offers an optimal control of oxidation and residue deposits as well as an excellent level of thermal stability and oxidation to ensure the longevity of equipment and long life performances.

#600000020	RotarECOFLUID 46 cSt - 1 x 3.8 L (3.3 kg) tank
#600000021	RotarECOFLUID 46 cSt - 1 x 20 L (17.36 kg) tank
#600000022	RotarECOFLUID 46 cSt - 1 x 200 L (174 kg) drum



# RotEnergy synthetic based lubricants

- ▶ Our synthetic based lubricants - **FSN RotEnergy** - have been specifically designed for use on our screw compressors, supplied by the world leading manufacturers. They are available in cans, drums or multiple packages: **RotEnergyPlus**: ensures quick water separation and lower frictions and energy consumptions, extends maintenance intervals and ensures excellent lubrication of the bearings while offering an excellent protection. **RotEnergyFood**: a high quality lubricant for rotary compressors, suitable for use in the food industry, where specific quality standards are required.

*We recommend changing synthetic or mineral oil according to the schedule provided in the compressor use and maintenance manual, or once a year. We suggest using our RotarECOFLUID and RotEnergy oil.*

#600000018A	RotEnergyPlus 46 cSt - 1 x 3.8 L (3.25 kg) tank
#600000009A	RotEnergyPlus 46 cSt - 4 tanks x 3.8 L (3.25 kg) each
#600000007A	RotEnergyPlus 46 cSt - 1 x 19 L (16 kg) tank
#600000012A	RotEnergyPlus 46 cSt - 1 x 208 L (181 kg) drum

#600000014A	RotEnergyFood 46 cSt - 4 tanks x 3.9 L (3.25 kg) each
#600000016A	RotEnergyFood 46 cSt - 1 x 19 L (18.5 kg) tank
#600000017A	RotEnergyFood 46 cSt - 1 x 208 L (175 kg) drum

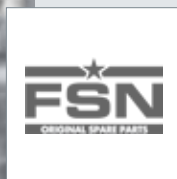

- ▶ All the exploded drawings and the spare parts lists for every compressor model are available at any time on the Fini and FSN website: [www.finicompressors.com](http://www.finicompressors.com)
- ▶ Our "Hot-Line" service is able to prepare and ship urgent orders on the same day.



- *Easy and fast online activation.*
- *You can choose to extend warranty to 3 or 5 years.*
- *Lower maintenance costs as a result of using original spare parts.*
- *Qualified assistance by authorised technicians.*



The "Trust" warranty can be easily extended online through EasyConnect, the new Fini service portal specially created to simplify customers' lives by providing them with quick, clear responses about product availability, order management and goods shipping times.



# Protect your investment, extend the Warranty up to **5** years!

When installing your new Fini screw compressor, join the "Trust" Warranty 3- to 5-year extension program to benefit from countless advantages by maximising the effectiveness, safety and duration over time of your investment. Thanks to scheduled maintenance programs exclusively performed by FINI Authorised Assistance Centres, you can rely on timely, highly professional service, as well as on the use of only original spare parts guaranteed by the FSN brand.



## A wide range of solutions for industrial applications



### **TERA**

Oil-injected rotary screw compressors, with direct transmission without gears, at fixed or variable speed and power values from 110 to 250 kW.



### **MICRO - PLUS**

Oil-injected rotary screw compressors, with belt transmission, at fixed or variable speed and power values from 2.2 to 75 kW.



### **OS Scroll**

Single and multi-scroll fixed speed oil-free compressors with power values from 2.2 to 30 kW.



### **AIR TREATMENT**

Air driers, filters, accessories and a wide range of products for compressed air treatment.



### **PROFESSIONAL**

Pumping units, base-plates and piston coaxial and belt-driven compressors, with power values from 0.75 to 20 HP.



### **FNA S.p.A.**

Registered office and Headquarter: Via Einaudi, 6 - 10070 Robassomero (TO) - Italy

Production plant: Via Toscana, 21 - 40069 Zola Predosa (BO) - Italy

Tel.: +39 011 9233000 - Fax: +39 011 9241138

[www.finicompressors.com](http://www.finicompressors.com) - [info@fnacompressors.com](mailto:info@fnacompressors.com)

